

baby jogger®

canopy replacement

CITY
TOUR™
2

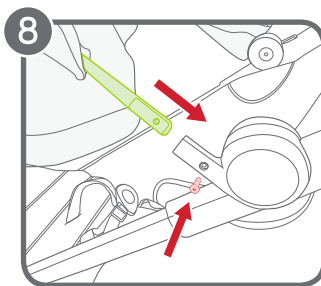

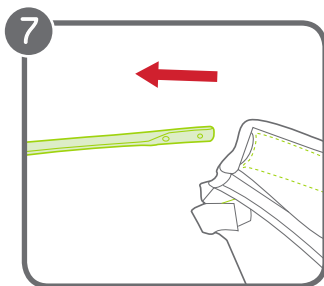
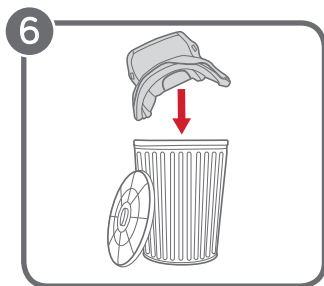
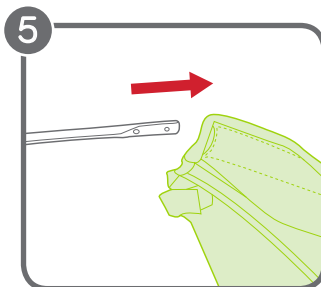
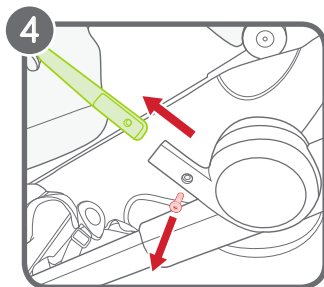
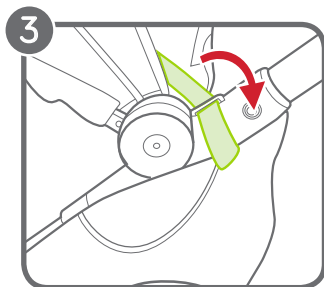
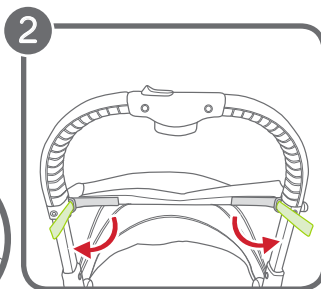
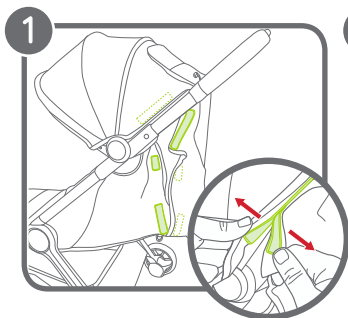
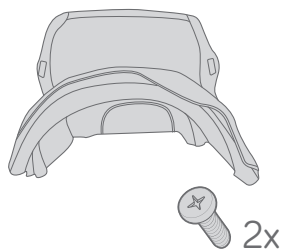
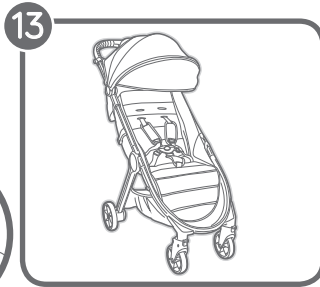
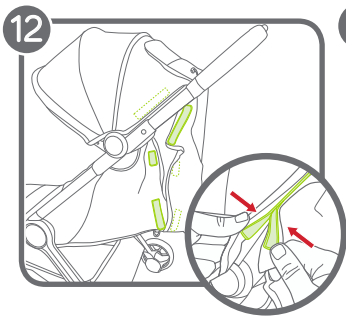
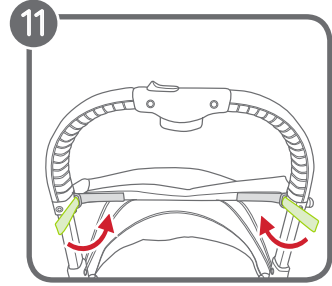
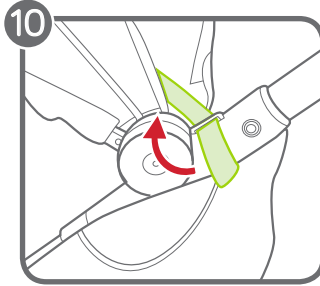
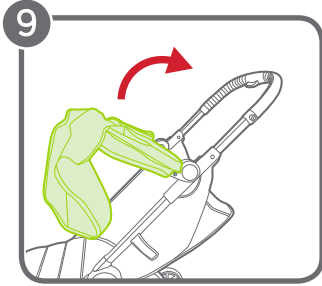

baby jogger
Baby Jogger, LLC

6655 Peachtree-Dunwoody Rd NE • Atlanta, GA 30328
1.800.241.1848 • www.babyjogger.com

Product of/Produit de:
Newell Europe Sarl
10 Chemin de Blandonnet • CH 1214 Vernier, Switzerland