

baby jogger[®]

canopy replacement

CITY TOUR™
DOUBLE 2

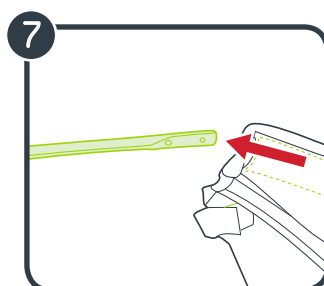

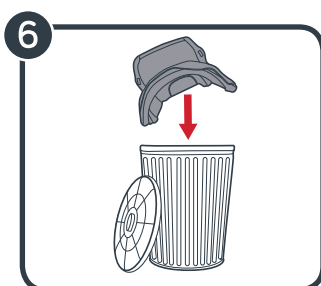
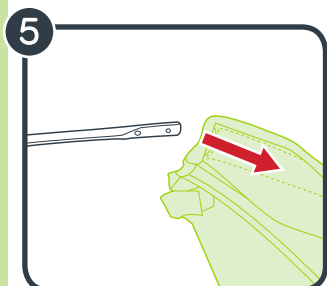
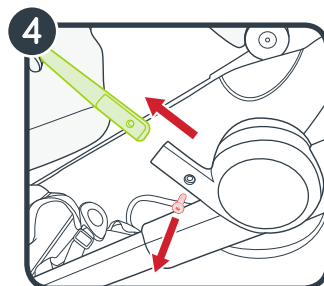
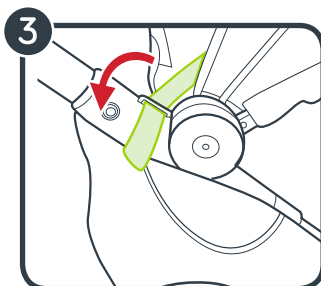
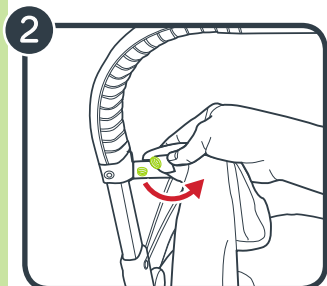
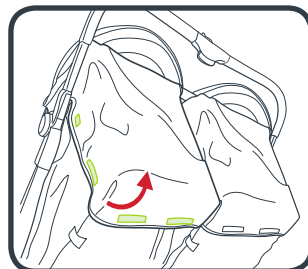
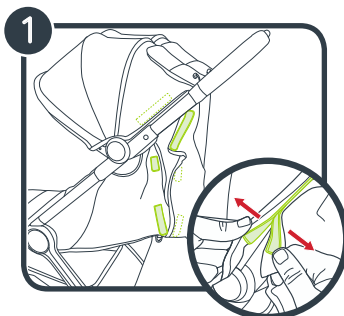
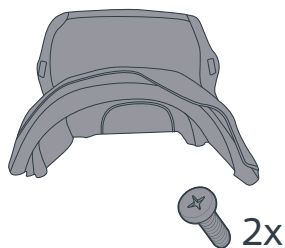
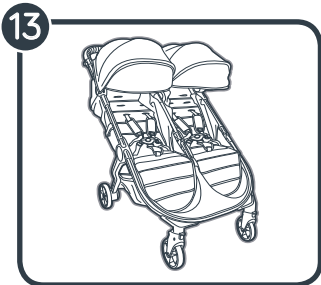
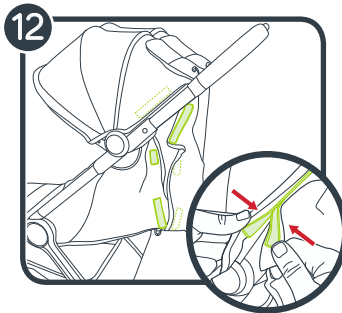
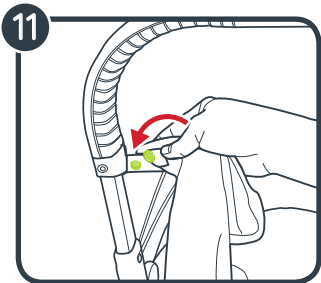
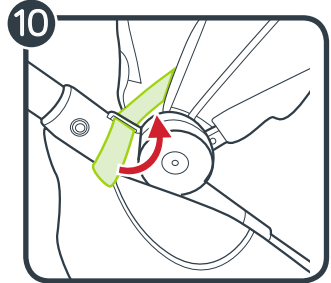
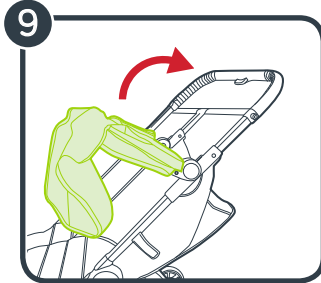
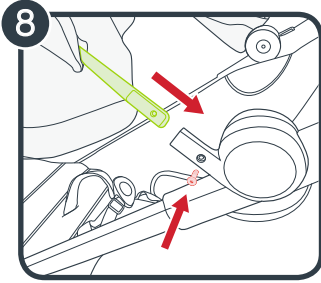

**baby
jogger®**
Baby Jogger, LLC

6655 Peachtree-Dunwoody Rd. NE • Atlanta, GA 30328
1.800.241.1848 • www.babyjogger.com

Product of/Produit de:
Newell Europe Sarl
10 Chemin de Blandonnet • CH 1214 Vernier, Switzerland